

# MHS-HP 26

gas-cooled

**Phase-out model**  
Insulation made of  
hard-plastic



240 Amp./100% duty cycle (DC)  
200 Amp./100% duty cycle (AC)

# MHS - HP 26

gas-cooled

- Equipment: **A** standard  
**B** gas lense  
**D** gas lens jumbo  
**F** standard mini

**Phase-out model**  
 Insulation made of  
 hard-plastic

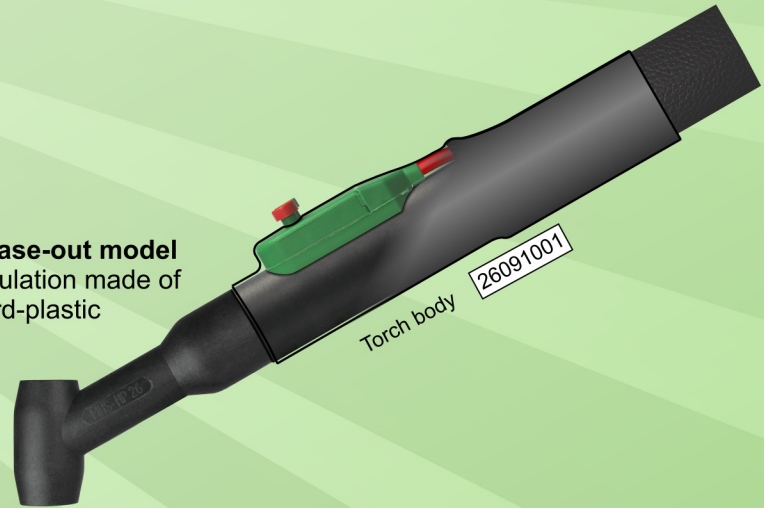

Torch body

26091001



O-ring red ID8-W2 mm included  
 17189001



**B**  
 Gas lens insulator  
 17089021

**D**  
 Gas lens insulator jumbo  
 17089031

**A**  
 Collet L50mm  
 17 □ 5002 for 1,0/1,6/2,4  
 18 □ 5002 for 3,2/4,0  
 □ Please fill in size

**B**  
 Collet L50mm  
 17 □ 5002 for 1,0/1,6/2,4  
 18 □ 5002 for 3,2/4,0  
 □ Please fill in size

**D**  
 Collet L50mm  
 17 □ 5002 for 1,0/1,6/2,4  
 18 □ 5002 for 3,2/4,0  
 □ Please fill in size

**F**  
 Collet L29mm  
 17 □ 3002 for 1,0/1,6/2,4  
 18323002 for 3,2  
 □ Please fill in size

Collet body  
 1796 □ 02 for 1,0/1,6/2,4  
 1896 □ 02 for 3,2/4,0  
 □ Please fill in size

Gas lens  
 1796 □ 11 for 1,0/1,6/2,4  
 1896 □ 11 for 3,2/4,0  
 □ Please fill in size

Gas lens jumbo  
 1796 □ 21 for 1,0/1,6/2,4  
 1896 □ 21 for 3,2/4,0  
 □ Please fill in size

Collet body mini  
 1796 □ 03 for 1,0/1,6/2,4  
 18963203 for 3,2  
 □ Please fill in size

Ceramic nozzle L47mm  
 for standard collet body  
**Please state size**  
 Also available in special length  
 L76mm

Ceramic nozzle L42mm  
 for gas lens  
**Please state size**  
 Also available in special length  
 L76mm

Ceramic nozzle L 48mm  
 for gas lens jumbo  
**Please state size**

Ceramic nozzle L30mm  
 for standard collet body mini  
**Please state size**  
 Also available in special lengths  
 L48mm / L63mm / L89mm

HSN 735BB-1



# MHS-HP 26 gas-cooled

240 Ampere at 100% duty cycle (DC) - 200 Ampere at 100% duty cycle (AC)



1



9



9.1



9.2

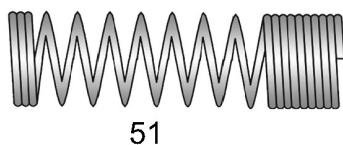
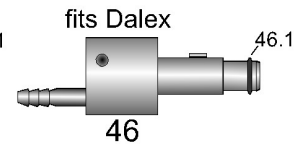
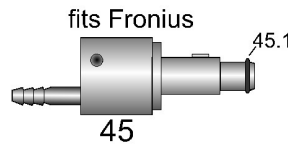
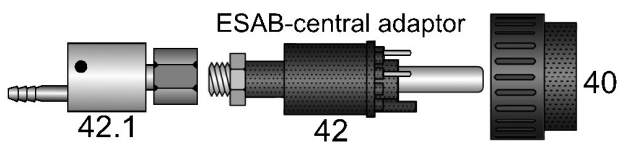
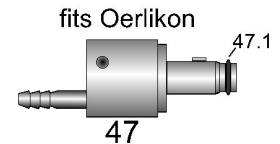
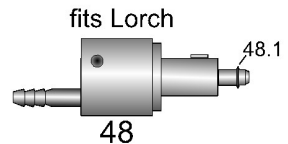
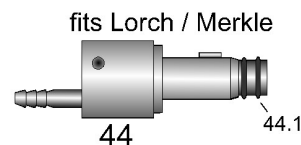
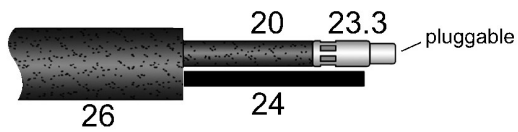
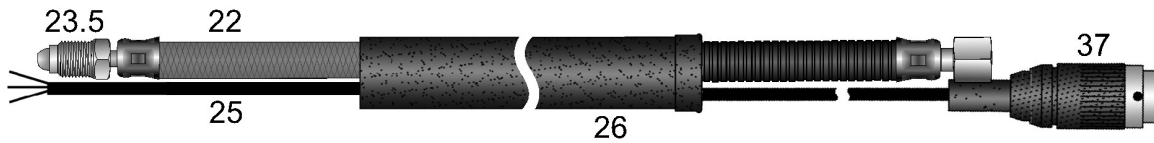
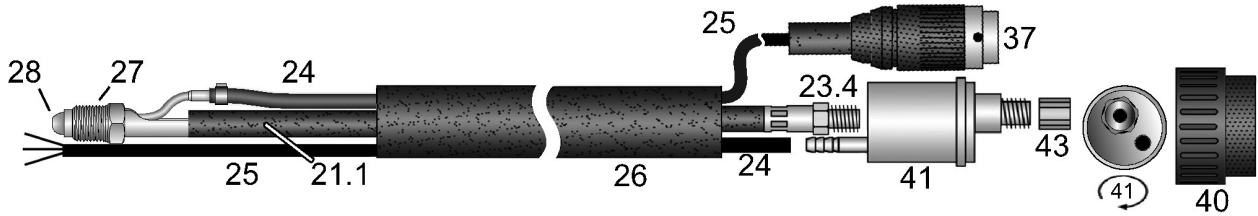
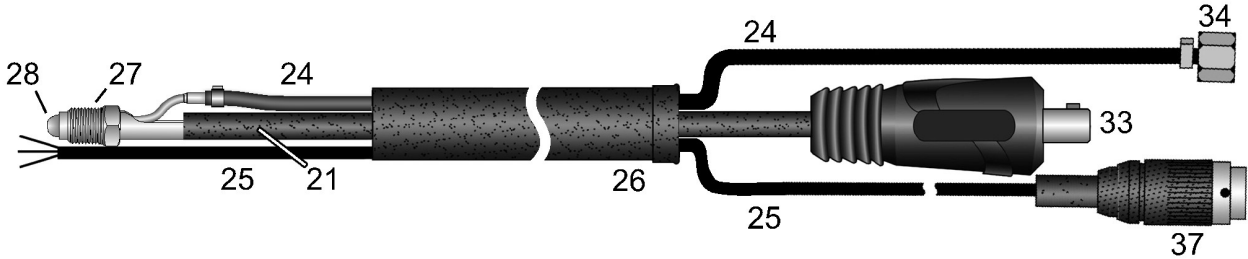

51



50

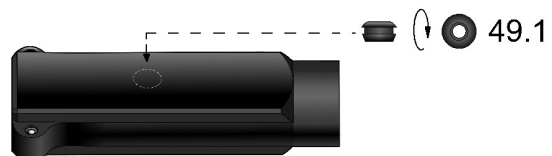

49

HSN 531BB

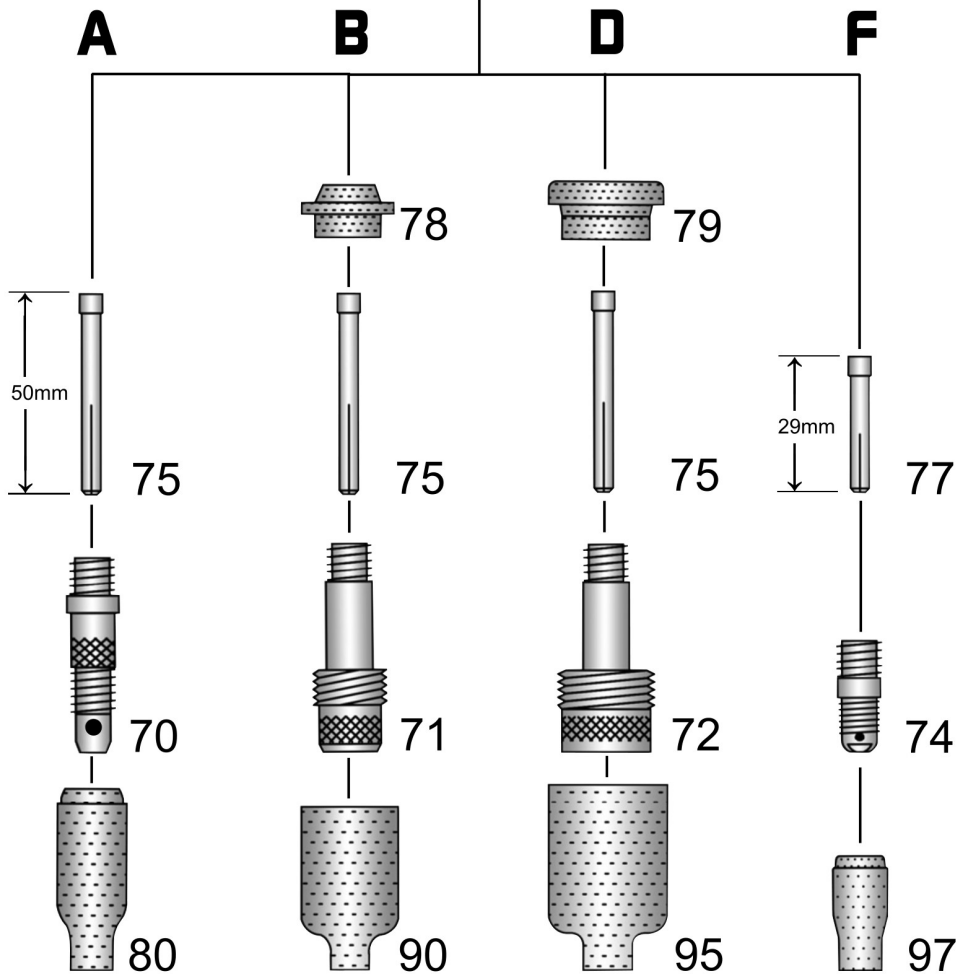
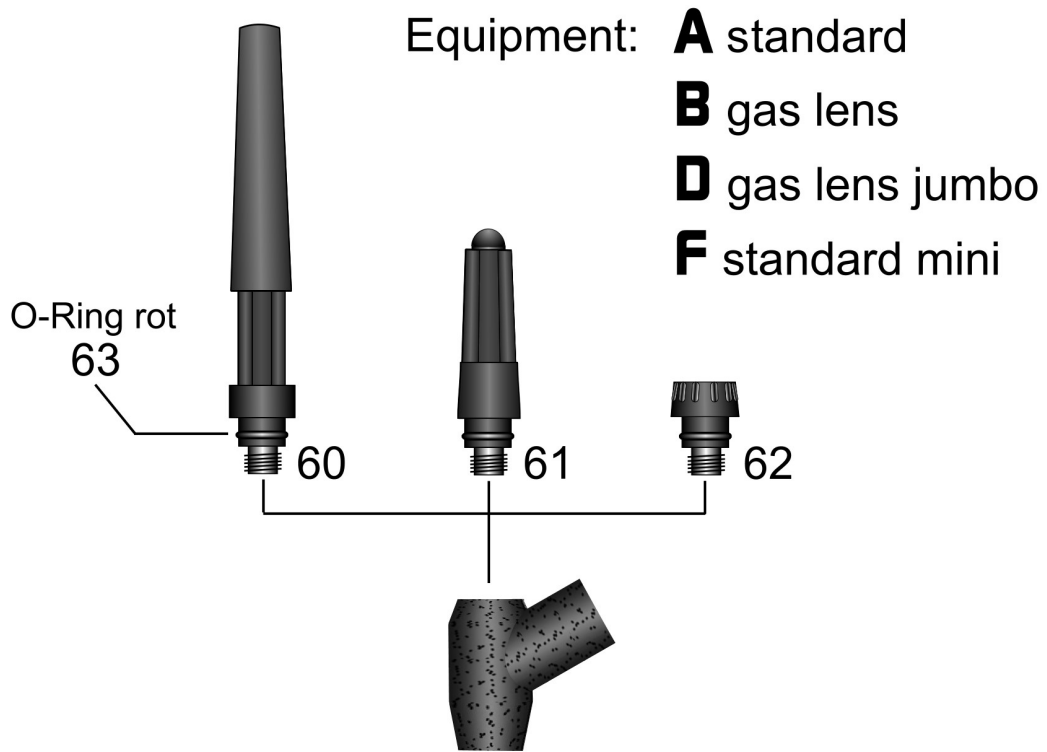



## MHS HP 26

### Welding-torch TIG gas-cooled with import torch body

240A at 100% duty cycle (DC) - 200A at 100% duty cycle (AC)

#### Art.-No.

**Torches with first meter leather hose. Prices without leather on request. Machine side separate connections with Tuchel-plug.**

**Torches and cable assemblies can be produced in excess lengths. Please find the different options and surcharges in the appendix C "Custom made products". We produce torches for more than 40 different brands of machines with different connection systems.**

26000401 Torch HP 26 / 4m

26000801 Torch HP 26 / 8m

**TIG-spare cable assemblies, either with separate connections, or for the following connection systems.**

wig92401 TIG-spare cable assembly gas-cooled 4m - please state desired design!

wig92801 TIG-spare cable assembly gas-cooled 8m - please state desired design!

**The following machine side connections are only listed for fast price finding purposes. In our catalogue "TIG machine side connections" you'll find technical information specifying a machine side connection.**

29000101 Surcharge: machine side with EURO central adapter

29002005 Surcharge: machine side power/gas plug fits Lorch/Merkle with 2 O-rings

29002004 Surcharge: machine side power/gas plug fits Fronius with 1 O-ring

29002006 Surcharge: machine side power/gas plug fits Dalex with 1 O-ring

29002107 Surcharge: machine side power/gas plug fits Oerlikon with 1 O-ring

29002002 Surcharge: machine side power/gas plug fits Lorch SK35 + gas-nipple

29000112 Surcharge: machine side fits ESAB central adapter, 4 pins installed at position 3,4,5,6

**Please be aware that further surcharges may apply for some special control-line plugs. See appendix D.**

1 26091001 Torch body HP 26

9 26088003 Handle H-200 fits SR 18 / SR 26

9.1 10089001 Single stroke button (rubber)

9.2 91921301 Doublepush button red/green

N.i. 10089011 One-hole shrinking hose switch sleeve ID50mm - min 25mm

N.i. 10089012 Two-hole shrinking hose switch sleeve ID50mm - min 25mm

20 26940403 Power cable 35mm<sup>2</sup> SR 26 / 4m fits power/gas plugs + power gas junction (pgj)

20 26940803 Power cable 35mm<sup>2</sup> SR 26 / 8m fits power/gas plugs + power gas junction (pgj)

21 26940402 Power cable 35mm<sup>2</sup> SR 26 / 4m with SK25 or SK-35 <--- please state!

21 26940802 Power cable 35mm<sup>2</sup> SR 26 / 8m with SK25 or SK-35 <--- please state!

21.1 26940404 Power cable 35mm<sup>2</sup> SR 26 / 4m EURO fits central adapter (OT-M10x1)

21.1 26940804 Power cable 35mm<sup>2</sup> SR 26 / 8m EURO fits central adapter (OT-M10x1)

**Please state the machine side connection for the following power/gas cables.**

22 26940401 ST 80 TURBOFLEX power/gas conduit 27mm<sup>2</sup> SR 26/230-S / 4m

22 26940801 ST 80 TURBOFLEX power/gas conduit 27mm<sup>2</sup> SR 26/230-S / 8m

23.3 22089057 TIG-Power cable connector pluggable ID8,2mm fits 35mm<sup>2</sup>

23.4 22089054 TIG-Power cable connector OT-M10x1 ID8,2mm fits 35mm<sup>2</sup>

23.5 12058001 Powercable connector AD12mm OT-5/8"UNF-right-hand

## MHS HP 26

### Welding-torch TIG gas-cooled with import torch body

240A at 100% duty cycle (DC) - 200A at 100% duty cycle (AC)

<b>Art.-No.</b>		
<b>Reel goods:</b> <b>Prices are given per meter and only valid for purchase of complete reels</b>		
24	41500001	Meter ST 70 PVC hose ID4,0-W1,5mm black for gas (100m)
N.i.	91902701	Meter control line 3x0,34mm <sup>2</sup> shielded black (100m)
N.i.	91902711	Meter control line 3x0,5mm <sup>2</sup> green (100m)
25	91902721	Meter control line 5x0,25mm <sup>2</sup> grey (100m)
26	22150002	Meter neoprene protective hose ID22mm black (40m)
27	91907601	Power cable connector separate lines OT-5/8"UNF-right-hand thread
28	91907612	Hose connector L105mm SR 26 pistol side
N.i.	91915004	Leather protective hose ID22mm / 1 meter long
N.i.	91915007	Leather protective hose ID22mm / 1 meter long with ball joint and hose connector
N.i.	91915013	Hose connector leather protective hose / protection hose ID22,5mm (black) with slot, OD with grooves
33	91918201	Powercable-plug SK-25 bayonet connection AD8mm
N.i.	91918321	Powercable plug SK25 with separate gas inlet, power-/gas connection OT-M12x1
33	91918301	Powercable-plug SK-35 bayonet connection AD13mm
N.i.	91918311	Powercable plug SK35 with separate gas inlet, power-/gas connection OT-M12x1
34	91901501	Coupling nut IT-G1/4"
N.i.	91901211	Hose connector 4mm fits coupling nut R1/4"
37	91904101	Plug 3-poles Tuchel with bayonet-catch
37	91904111	Plug 5-poles Tuchel with bayonet-catch
<b>More control line plugs please see appendix D.</b>		
40	91900701	Terminal nut insulated fits EURO central adapter
41	91900122	TIG central adapter EURO (fits separate lines)
N.i.	91900121	TIG central adapter EURO with IT-M10x1 (fits power/gas conduit)
42	91900301	TIG central adapter identical ESAB, 4 contact pins at position 3,4,5,6
42.1	91918561	TIG power gas junction (pgj) fits ESAB central adapter
43	91900901	Swivel nut IT-M10x1 (rounded edges) fits EURO central adapter
44	9190411n	Power/gas plug fits Lorch / Merkle with 2 O-rings / power connection like pgj
44.1	81600001	O-ring ID8-W1,6mm fits Lorch/Merkle
45	91918326	Power/gas plug fits Fronius with 1 O-ring / power connection like pgj
45.1	62190001	O-ring ID6,2-W1,9mm fits Fronius
46	9190416e	Power/gas plug fits Dalex with 1 O-ring / power connection like pgj
46.1	63240001	O-ring ID6,3-W2,4mm fits Dalex
47	9190422n	Power/gas plug fits Oerlikon with 1 O-ring / power connection like pgj
47.1	60717801	O-ring ID6,07-W1,78mm fits Oerlikon
48	9190421n	Power/gas plug fits Lorch Sk35 + gas-nipple / power connection like pgj
48.1	91900801	O-ring ID4-W1mm fits gas-nipple EURO central adapter
49	91900556	TIG cable support short with screws (fits gas-cooled)
N.i.	91920702	Screw M3x11,5mm fits Ratio/Industry/RAUCH handle and cable support
N.i.	91920703	M3 mounting socket fits Ratio/Industry/RAUCH handle and cable support
o.A.	91900602	Screw M4x6mm fits TIG cable support short
49.1	91901012	Reduction-eyelet (rubber) from ID10,5mm to ID5mm fits TIG cable support short

## MHS HP 26

### Welding-torch TIG gas-cooled with import torch body

240A at 100% duty cycle (DC) - 200A at 100% duty cycle (AC)

<b>Art.-No.</b>		
50	91912801	Spring-socket fits cable support
51	91912601	Cable support spring
N.i.	91900552	TIG cable support long (like MIG-MAG) with screws fits ESAB central adapter
N.i.	91900554	Attachment screw M4x8mm fits ESAB central adapter
60	17191311	Holch back cap long (USA version with red O-ring) SR 17-18-26 57Y02
61	17191322	Import back cap medium (USA version with red O-ring) SR 17-18-26 57Y03
62	17191301	Holch back cap short (USA version with red O-ring) SR 17-18-26 57Y04
63	17189001	O-ring red ID8-W2mm for back cap
70	17961002	Collet body 17-18-26-220 / 1,0 10N30
70	17961602	Collet body 17-18-26-220 / 1,6 10N31
70	17962402	Collet body 17-18-26-220 / 2,4 10N32
70	18963202	Collet body 17-18-26-220 / 3,2 10N28
71	17961011	Gas lens 17-18-26-220 / 1,0 45V24
71	17961611	Gas lens 17-18-26-220 / 1,6 45V25
71	17962411	Gas lens 17-18-26-220 / 2,4 45V26
71	18963211	Gas lens 17-18-26-220 / 3,2 45V27
72	17961021	Jumbo-Gas lens 17-18-26-220 / 1,0 45V0204
72	17961621	Jumbo-Gas lens 17-18-26-220 / 1,6 45V116
72	17962421	Jumbo-Gas lens 17-18-26-220 / 2,4 45V64
72	18963221	Jumbo-Gas lens 17-18-26-220 / 3,2 995795
74	18961003	Collet body "Mini" SR 17-18-26 1,0 conversion kit
74	18961603	Collet body "Mini" SR 17-18-26 1,6 conversion kit
74	18962403	Collet body "Mini" SR 17-18-26 2,4 conversion kit
74	18963203	Collet body "Mini" SR 17-18-26 / 1,0 - 3,2 17CB20 conversion kit
<b>Brazen collets L-50mm for equipment line (A) standard collet body for equipment line (B) gas lens for equipment line (D) Jumbo gas lens</b>		
75	17105002	Collet L50mm SR 17-18-26 wp-18SC / 1,0 10N22
75	17165002	Collet L50mm SR 17-18-26 wp-18SC / 1,6 10N23
75	17245002	Collet L50mm SR 17-18-26 wp-18SC / 2,4 10N24
75	18325002	Collet L50mm SR 17-18-26 wp-18SC / 3,2 10N25
<b>Copper collets L-29mm for equipment line (F) standard colletbody mini</b>		
77	17103002	Collet L29mm SR 17-18-26 "Mini" 1,0 10N22S
77	17163002	Collet L29mm SR 17-18-26 "Mini" 1,6 10N23S
77	17243002	Collet L29mm SR 17-18-26 "Mini" 2,4 10N24S
77	18323002	Collet L29mm SR 17-18-26 "Mini" 3,2 10N25S
78	17089021	PTFE-Gas-lens insulator 17-18-26-220 54N01
79	17089031	PTFE-Gas-lens insulator Jumbo 17-18-26-220 54N63
<b>Ceramic gas nozzles in different lengths for equipment line (A) standard collet body</b>		
80	17930401	Ceramic gas nozzle L47mm 17-18-26-220 / Gr.4 10N50 (pu=10pieces)

## MHS HP 26

### Welding-torch TIG gas-cooled with import torch body

240A at 100% duty cycle (DC) - 200A at 100% duty cycle (AC)

<b>Art.-No.</b>		
80	17930501	Ceramic gas nozzle L47mm 17-18-26-220 / Gr.5 10N49 (pu=10pieces)
80	17930601	Ceramic gas nozzle L47mm 17-18-26-220 / Gr.6 10N48 (pu=10pieces)
80	17930701	Ceramic gas nozzle L47mm 17-18-26-220 / Gr.7 10N47 (pu=10pieces)
80	17930801	Ceramic gas nozzle L47mm 17-18-26-220 / Gr.8 10N46 (pu=10pieces)
80	17930101	Ceramic gas nozzle L47mm 17-18-26-220 / Gr.10 10N45 (pu=10pieces)
80	17930121	Ceramic gas nozzle L47mm 17-18-26-220 / Gr.12 10N44 (pu=10pieces)
N.i.	17930404	Ceramic gas nozzle L76mm 17-18-26-220 / Gr.4 10N50L (pu=10pieces)
N.i.	17930504	Ceramic gas nozzle L76mm 17-18-26-220 / Gr.5 10N49L (pu=10pieces)
N.i.	17930604	Ceramic gas nozzle L76mm 17-18-26-220 / Gr.6 10N48L (pu=10pieces)
N.i.	17930704	Ceramic gas nozzle L76mm 17-18-26-220 / Gr.7 10N47L (pu=10pieces)

#### **Ceramic gas nozzles in different lengths for equipment line (B) gas lens**

90	22093041	Gas nozzle for gas lens L42mm / Gr.4 54N18 (pu=10pieces)
90	22093051	Gas nozzle for gas lens L42mm / Gr.5 54N17 (pu=10pieces)
90	22093061	Gas nozzle for gas lens L42mm / Gr.6 54N16 (pu=10pieces)
90	22093071	Gas nozzle for gas lens L42mm / Gr.7 54N15 (pu=10pieces)
90	22093081	Gas nozzle for gas lens L42mm / Gr.8 54N14 (pu=10pieces)
90	22093111	Gas nozzle for gas lens L42mm / Gr.11 54N19-11 (pu=10pieces)
90	22093121	Gas nozzle for gas lens L42mm / Gr.12 54N19 (pu=10pieces)
N.i.	22093054	Gas nozzle for gas lens L76mm / Gr.5 54N17L (pu=10pieces)
N.i.	22093064	Gas nozzle for gas lens L76mm / Gr.6 54N16L (pu=10pieces)
N.i.	22093074	Gas nozzle for gas lens L76mm / Gr.7 54N15L (pu=10pieces)

#### **Ceramic gas nozzles Jumbo in different lengths for equipment line (D) Jumbo gas lens**

95	22093066	Jumbo gas nozzle L48mm / Gr.6 57N75 (pu=10pieces)
95	22093086	Jumbo gas nozzle L48mm / Gr.8 57N74 (pu=10pieces)
95	22093106	Jumbo gas nozzle L48mm / Gr.10 53N88 (pu=10pieces)
95	22093126	Jumbo gas nozzle L48mm / Gr.12 53N87 (pu=10pieces)
N.i.	22093067	Jumbo gas nozzle L73mm / Gr.6 57N75L (pu=10pieces)
N.i.	22093087	Jumbo gas nozzle L73mm / Gr.8 57N74L (pu=10pieces)
N.i.	22093107	Jumbo gas nozzle L73mm / Gr.10 53N88L (pu=10pieces)
N.i.	22093127	Jumbo gas nozzle L73mm / Gr.12 53N87L (pu=10pieces)

#### **Ceramic gas nozzles different lengths for equipment line (F). Collet body standard mini**

97	20930401	Ceramic gas nozzle L30mm / Gr. 4 13N08 (pu=10pieces)
97	20930501	Ceramic gas nozzle L30mm / Gr. 5 13N09 (pu=10pieces)
97	20930601	Ceramic gas nozzle L30mm / Gr. 6 13N10 (pu=10pieces)
97	20930701	Ceramic gas nozzle L30mm / Gr. 7 13N11 (pu=10pieces)
97	20930801	Ceramic gas nozzle L30mm / Gr. 8 13N12 (pu=10pieces)
97	20930101	Ceramic gas nozzle L30mm / Gr.10 13N13 (pu=10pieces)
N.i.	20930304	Ceramic gas nozzle L48mm / Gr. 3 796F70 (pu=10pieces)
N.i.	20930404	Ceramic gas nozzle L48mm / Gr. 4 796F71 (pu=10pieces)
N.i.	20930504	Ceramic gas nozzle L48mm / Gr. 5 796F72 (pu=10pieces)
o.A	20930604	Ceramic gas nozzle L48mm / Gr. 6 796F73 (pu=10pieces)
N.i.	20930306	Ceramic gas nozzle L63mm / Gr. 3 796F74 (pu=10pieces)



## MHS HP 26

**Welding-torch TIG gas-cooled with import torch body**

**240A at 100% duty cycle (DC) - 200A at 100% duty cycle (AC)**

---

<b>Art.-No.</b>		
N.i.	20930406	Ceramic gas nozzle L63mm / Gr. 4 796F75 (pu=10pieces)
N.i.	20930506	Ceramic gas nozzle L63mm / Gr. 5 796F76 (pu=10pieces)
N.i.	20930606	Ceramic gas nozzle L63mm / Gr. 6 796F77 (pu=10pieces)
N.i.	20930408	Ceramic gas nozzle L89mm / Gr. 4 796F79 (pu=10pieces)

**Premium tungsten electrodes of 8 different kinds in the appendix A.**